

✂ 3 5 7 1 1 1 2

1 5 1 6 1 8 2 0

2 4 9

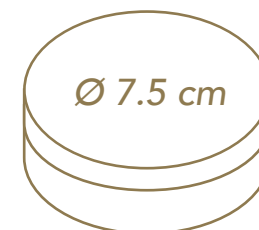

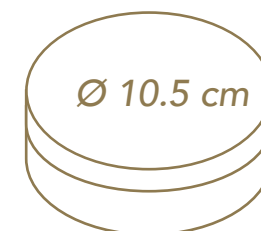
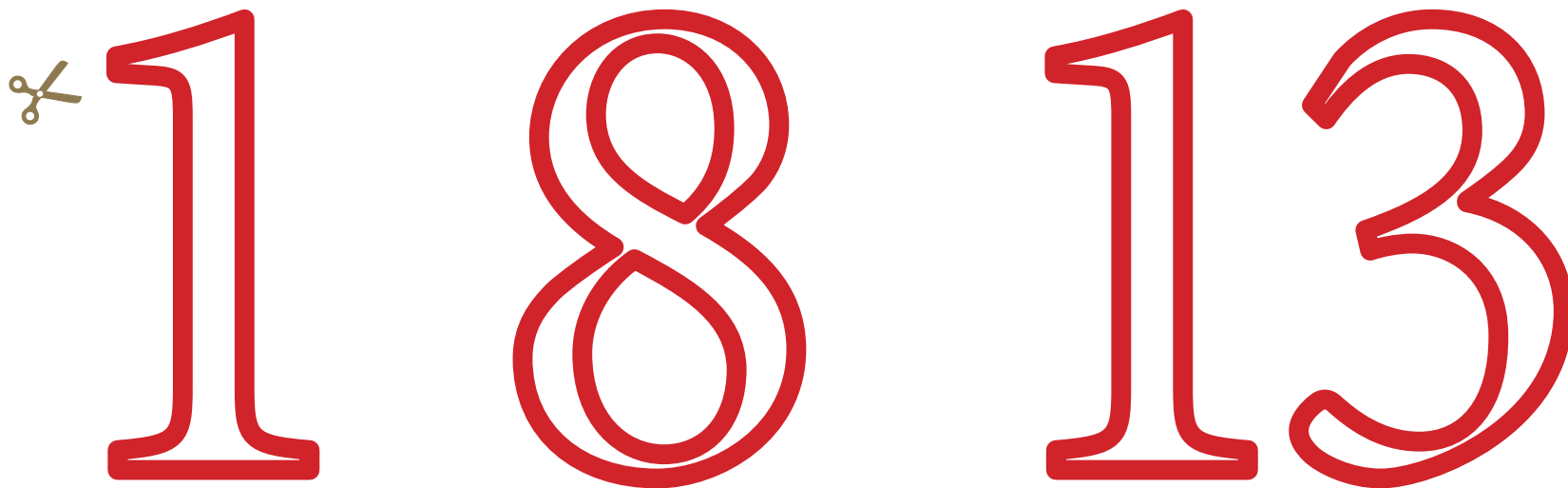



Zimski oblak

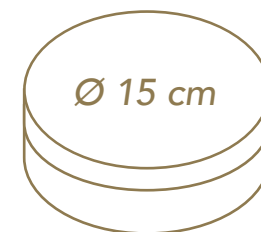
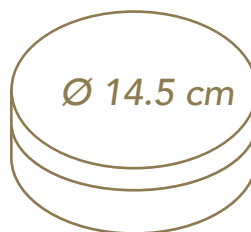

Prisrčni zlati snežak

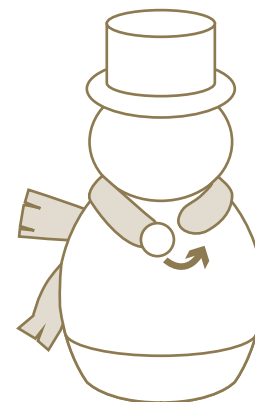
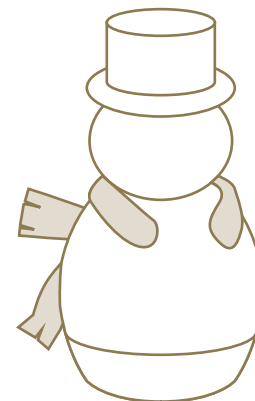
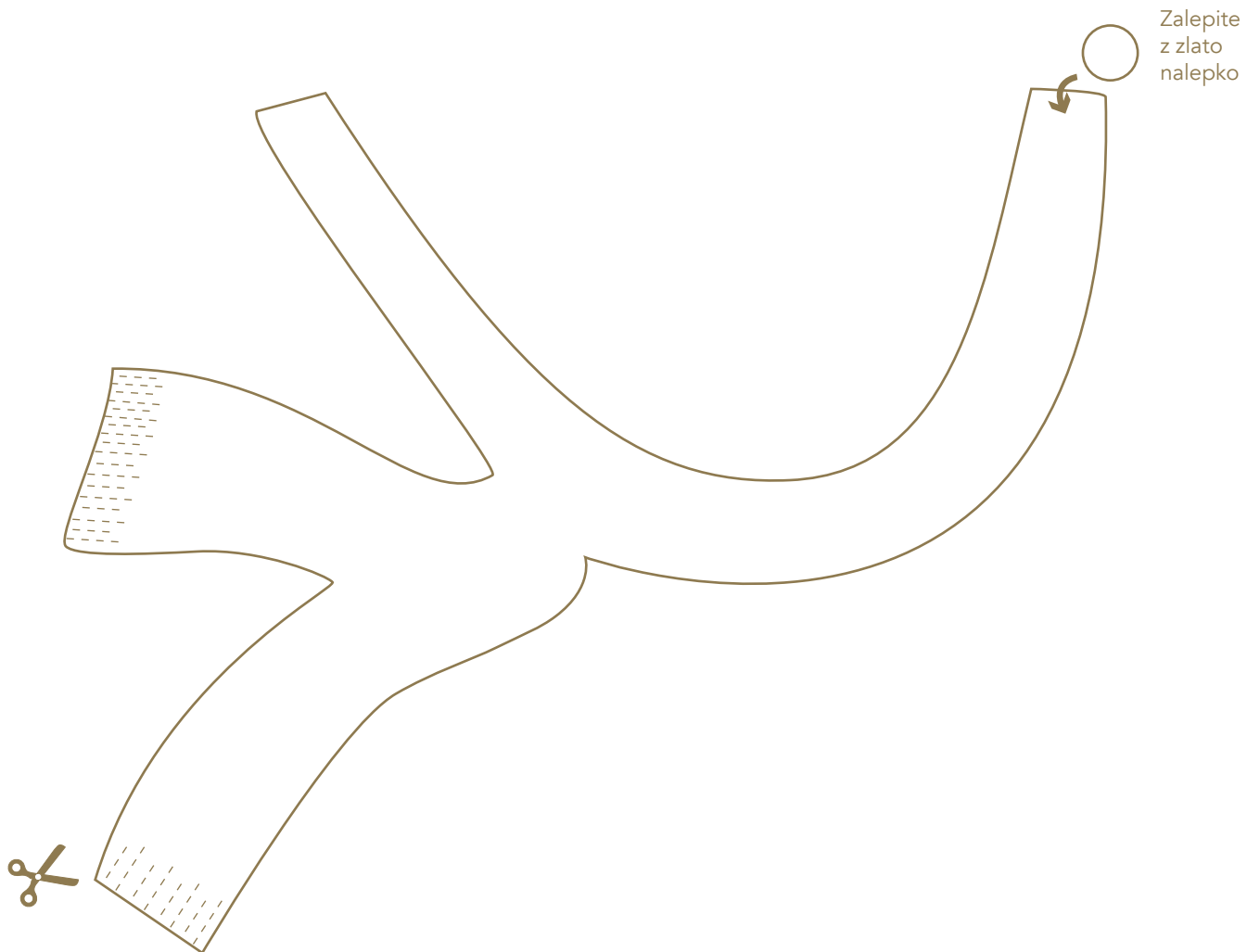

Sveta noč

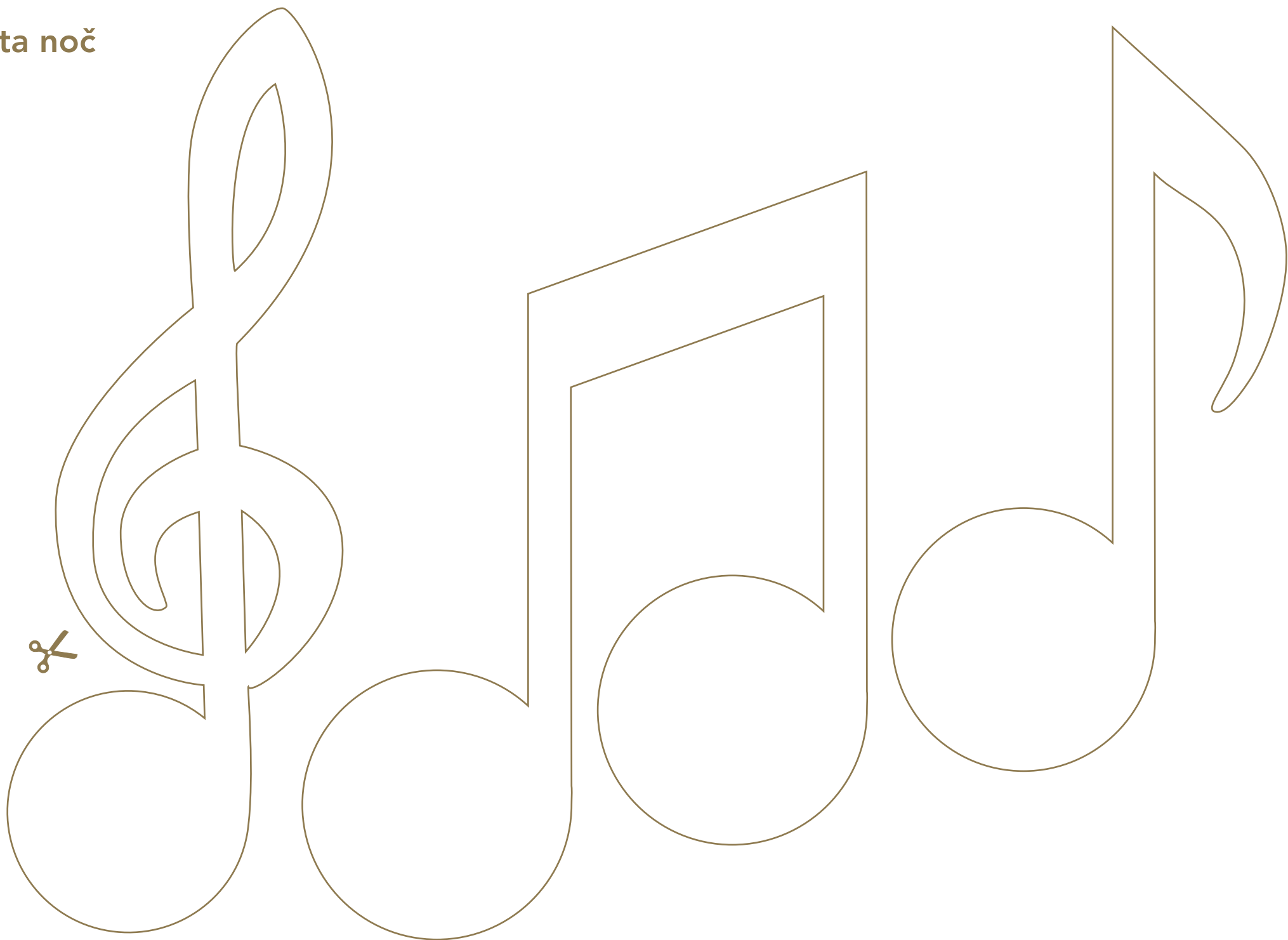

Božično mesto

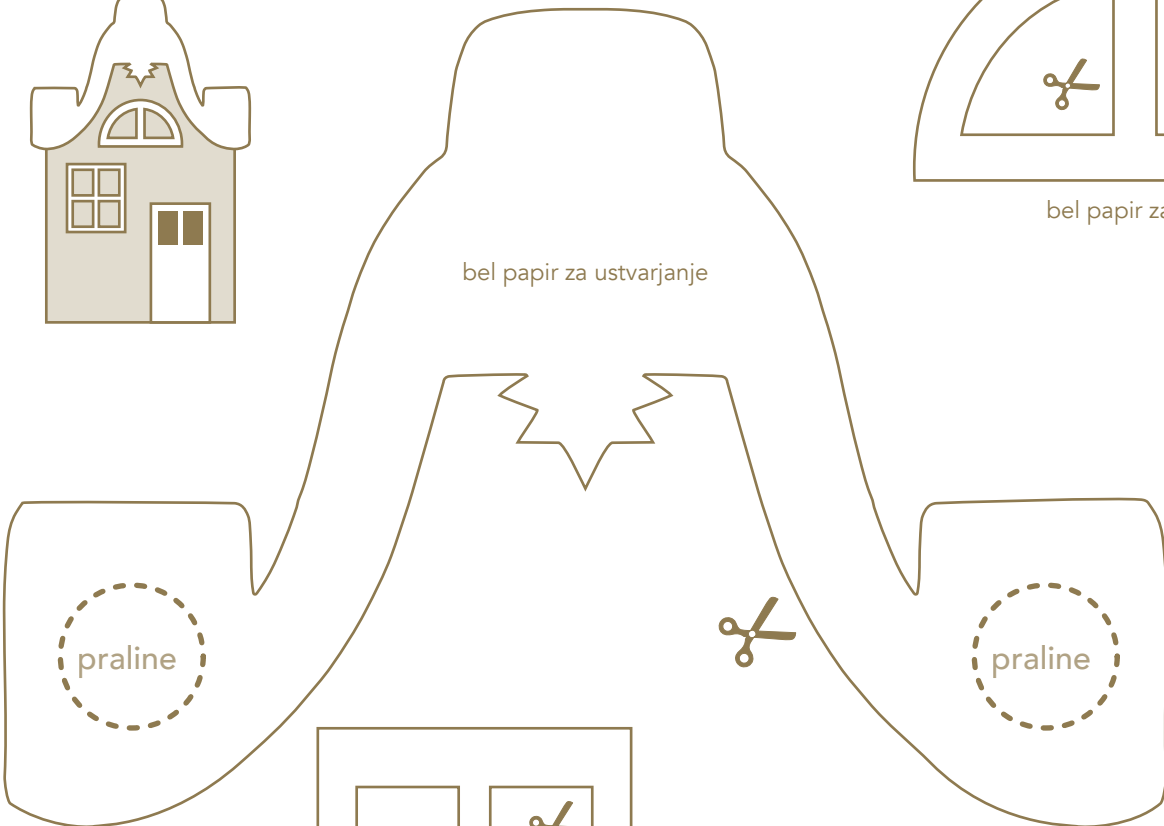

bel papir za ustvarjanje

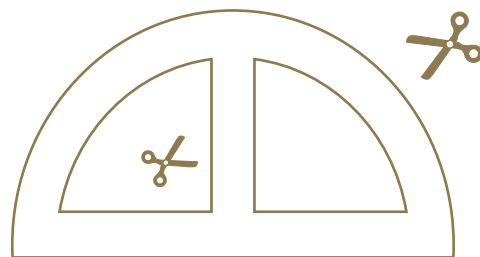

bel papir za ustvarjanje



zelenomoder
papir za
ozadje



bel papir za ustvarjanje

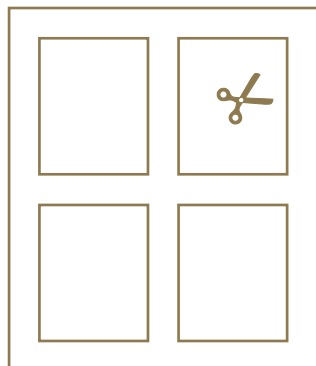

bel papir za ustvarjanje



oranžen papir, narejen po šabloni

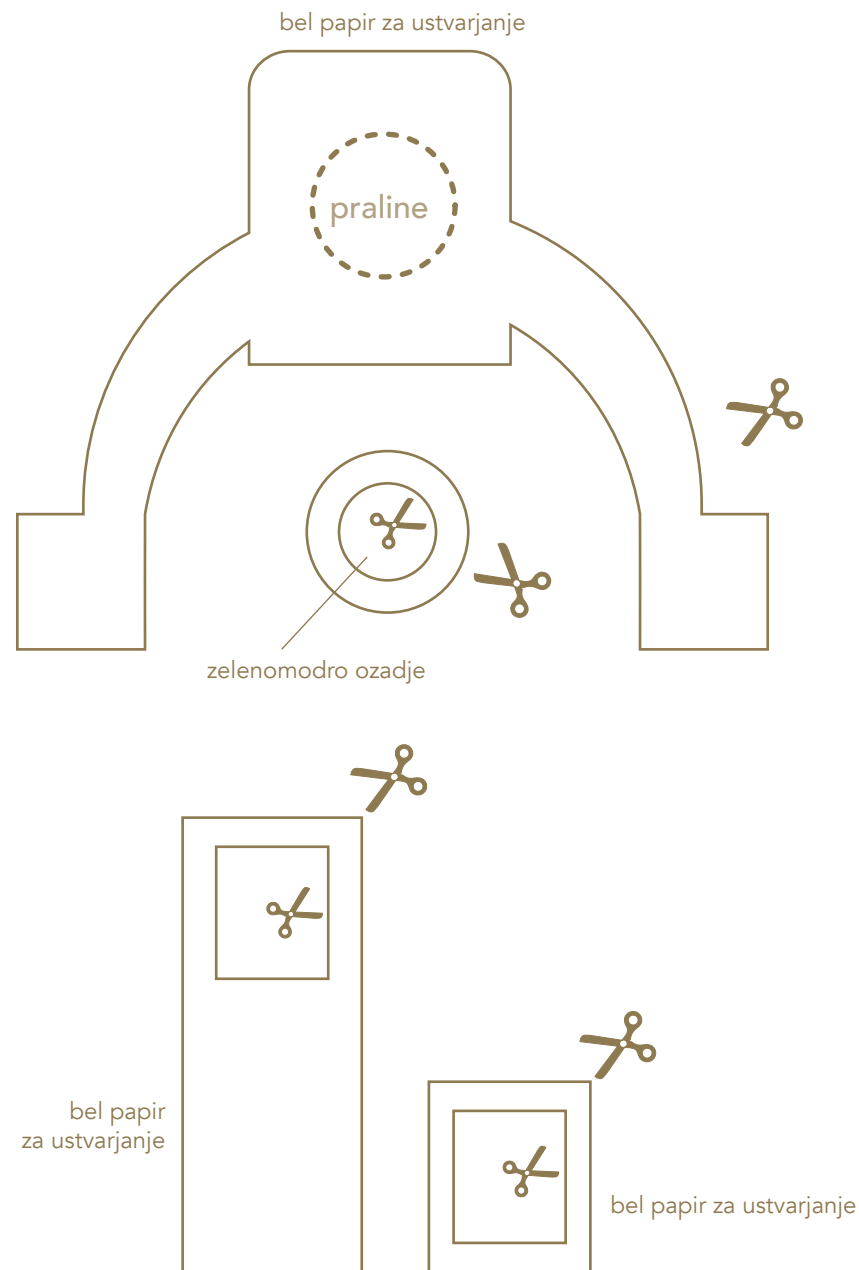
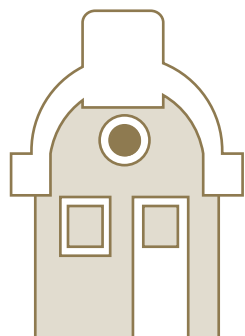

Božično mesto

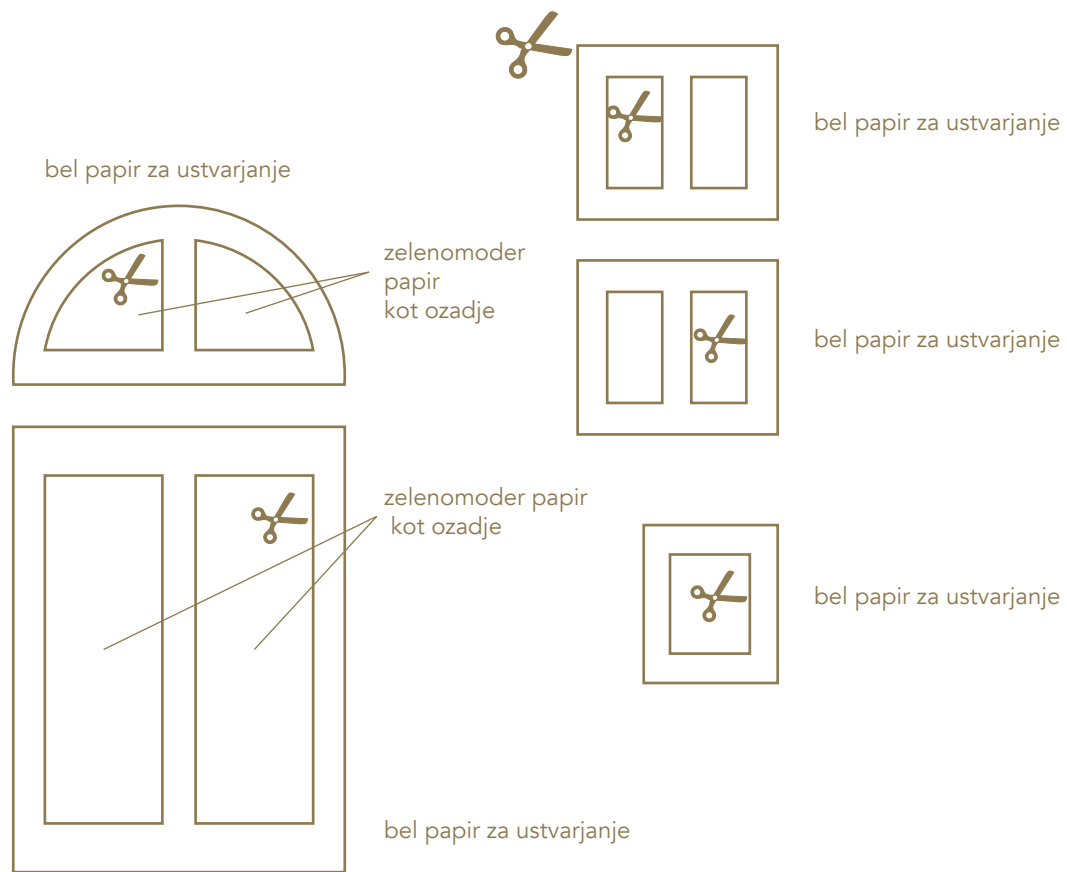
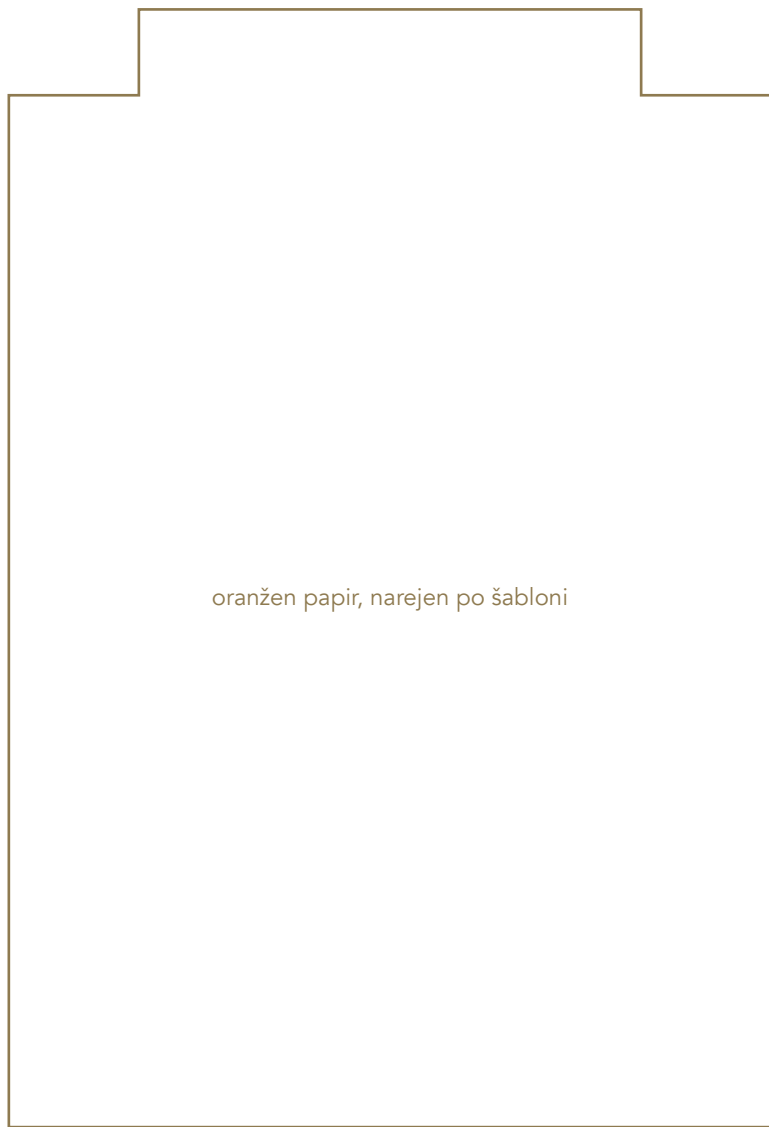
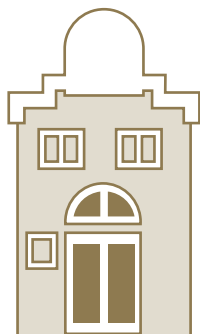

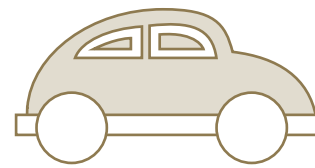
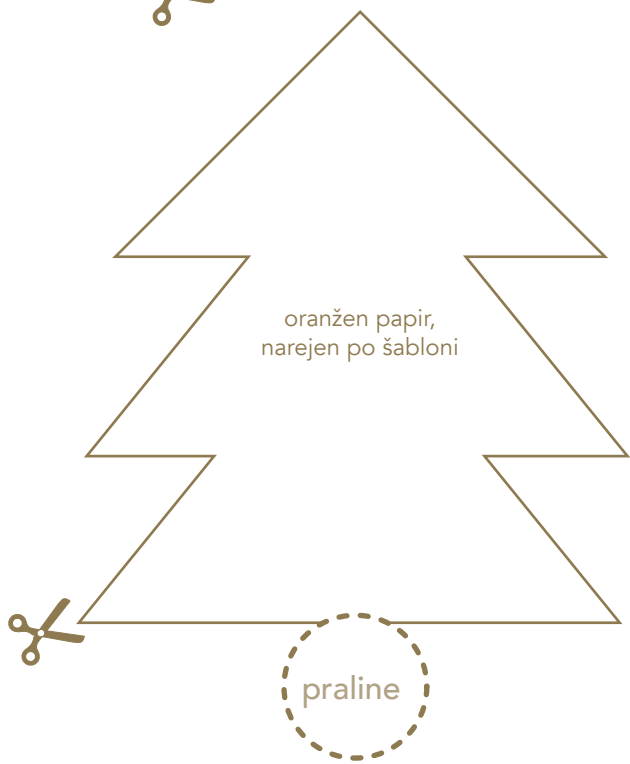

Glasbene smrečice

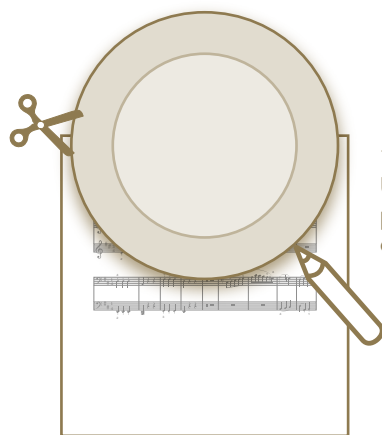

1 Uporabite krožnik kot predlogo za polkrog in odrežite vzdolž črte.



2 Obrnite.

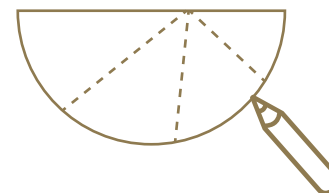

3 Narahlo označite črte prepogibanja na papirju.

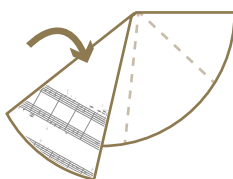

4 Prepognite levo stran čez desno (pustite 1 cm prostora do naslednje črte za prepogibanje).

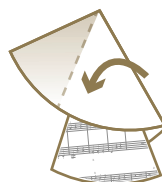

5 Prepognite desno stran na drugo črto prepogibanja proti levi strani (pustite 1 cm prostora do naslednje črte prepogibanja).



6 Obrnite.



7 Zapognite vrh desne strani proti levi (pustite 1 cm prostora do zadnje črte prepogibanja).

Bleščeč venček

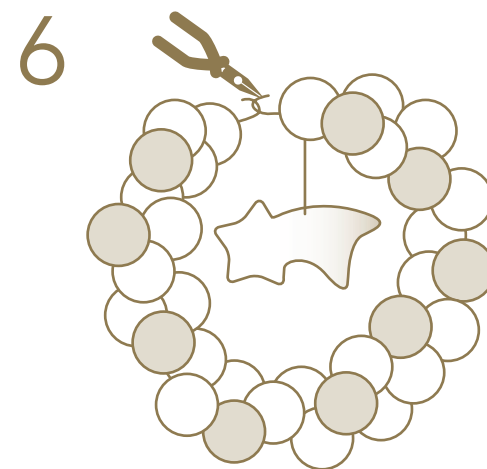
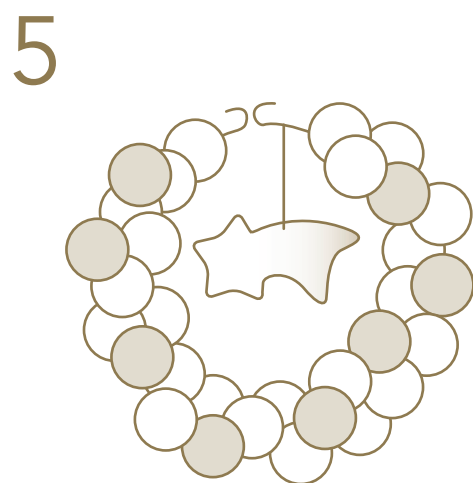
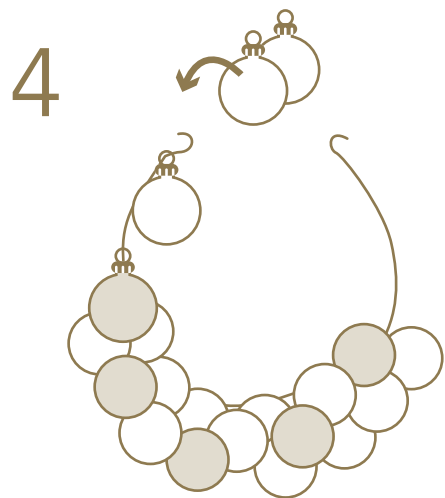
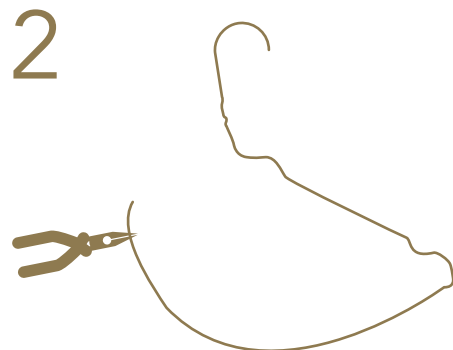
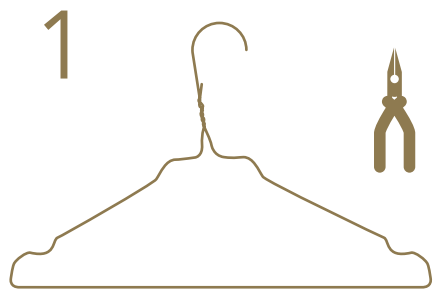

Dvodimenzionalna smrečica

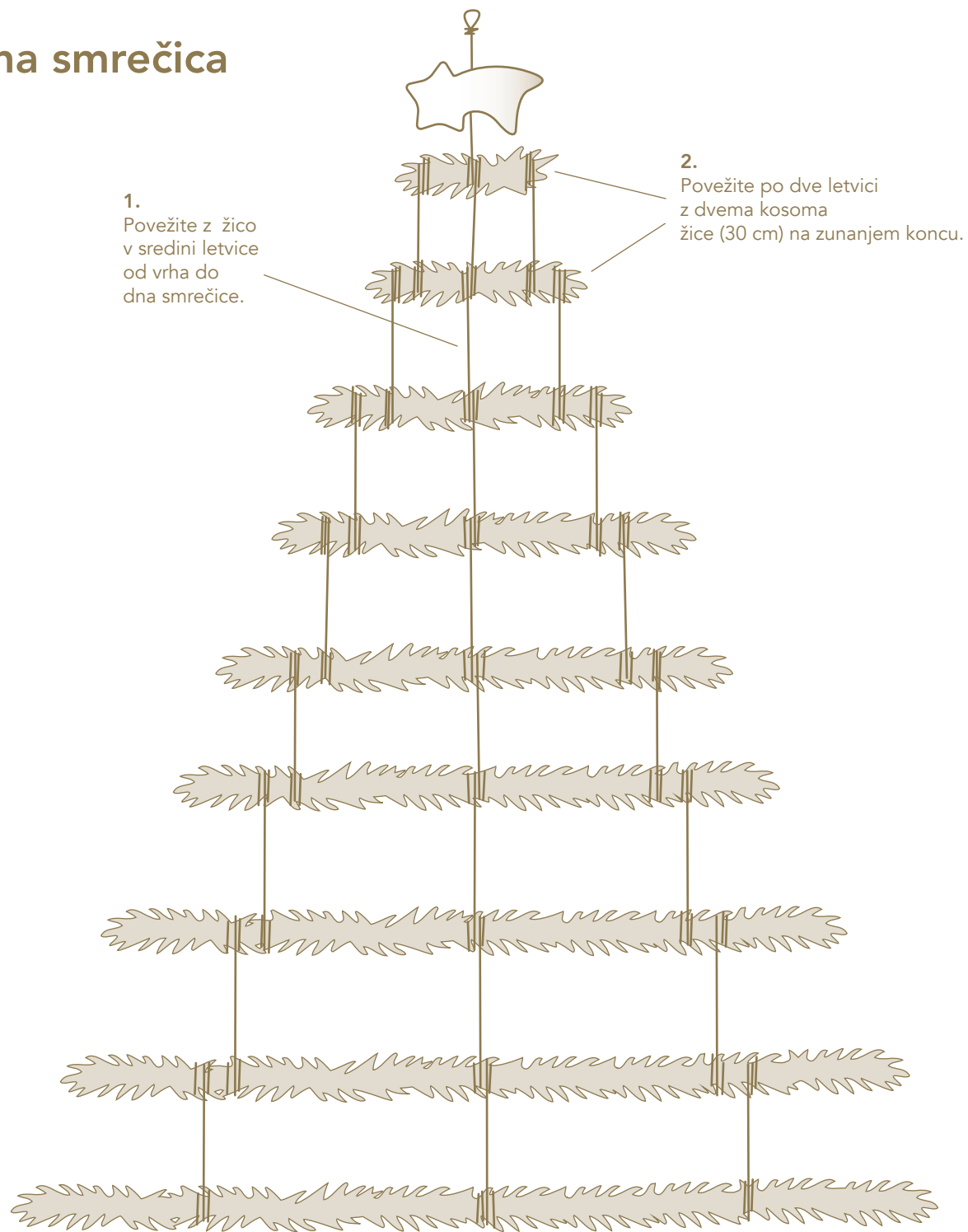

Novoletni kolački

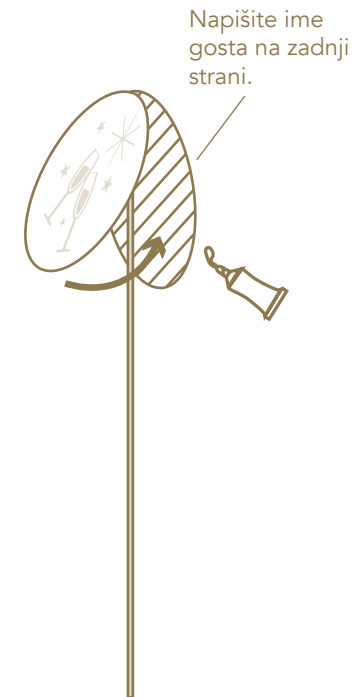

Zgibane smrečice

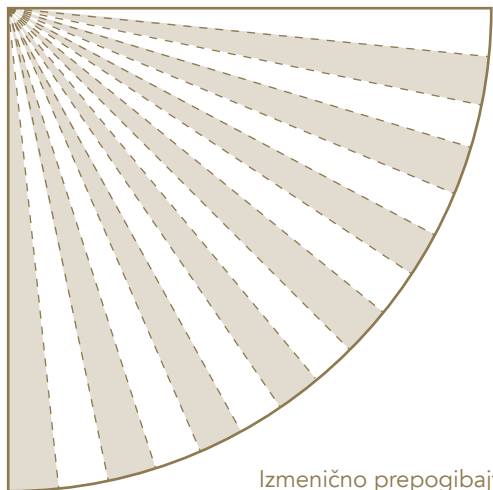

Izmenično prepogibajte
naprej in nazaj.

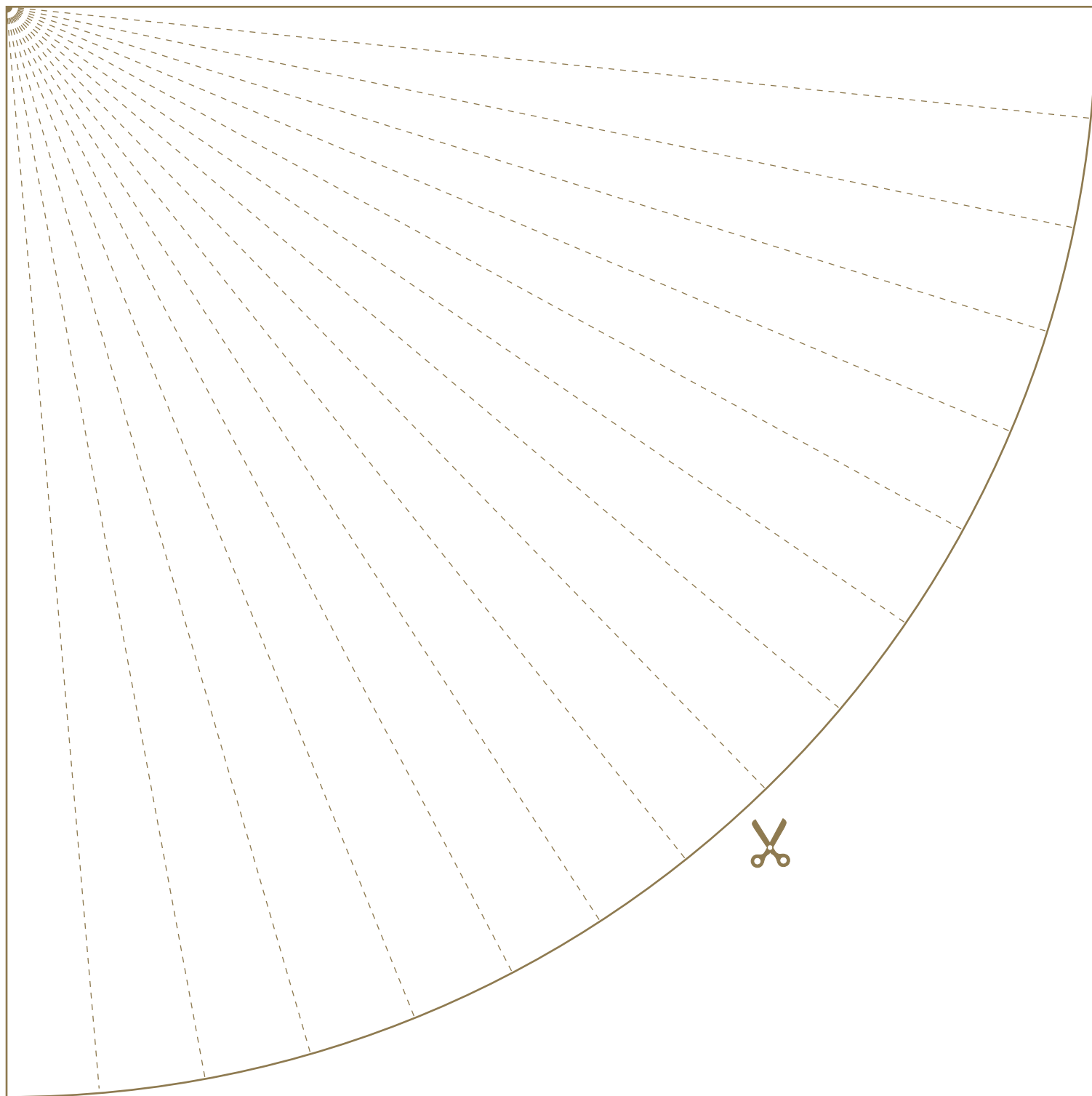
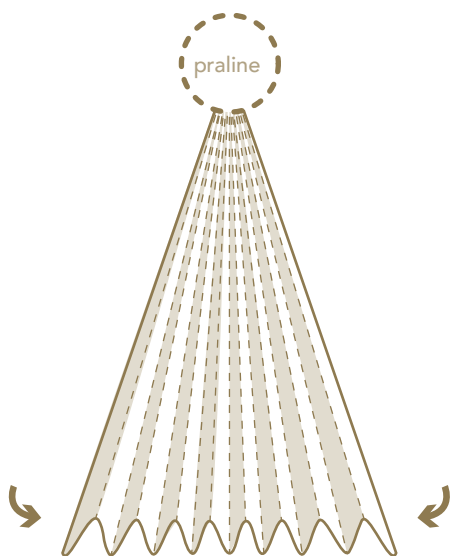

Čarobne zvezde

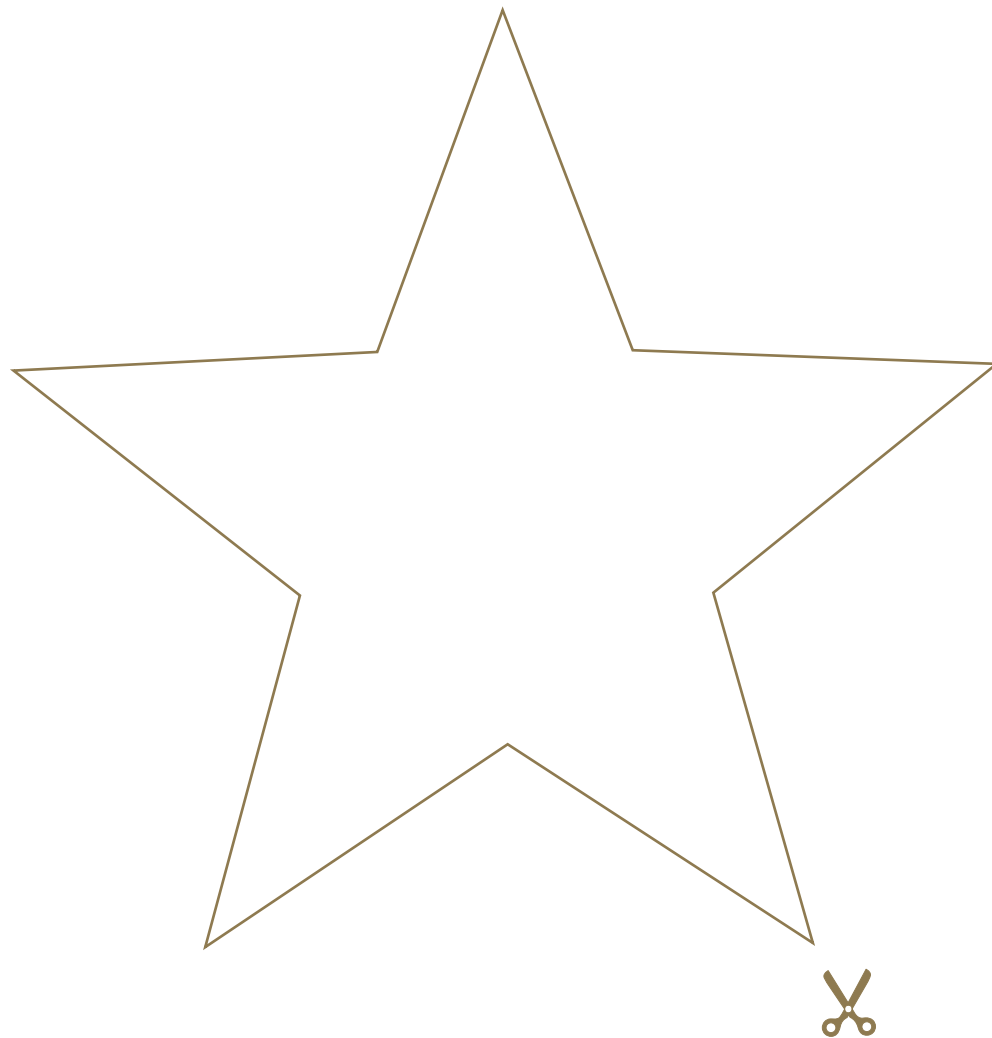

Naj bo srečno in veselo



1
Iz žameta izrežite dva škornja.

2
Izrežite dva škornja
iz bombažnega blaga.

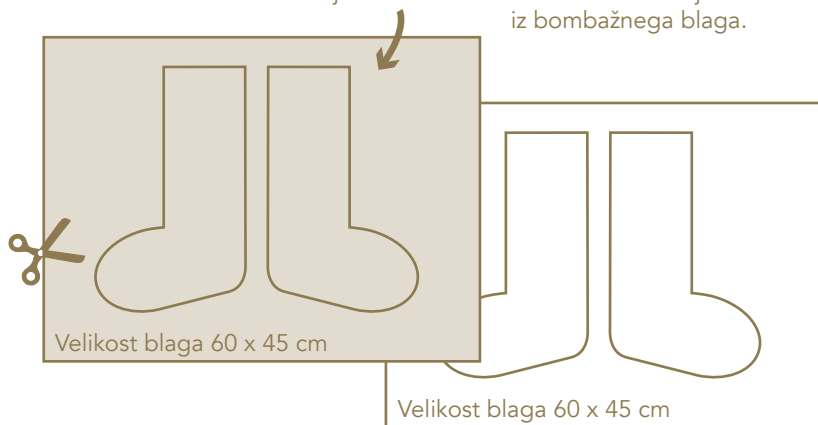

Žamet

Bombažna tkanina

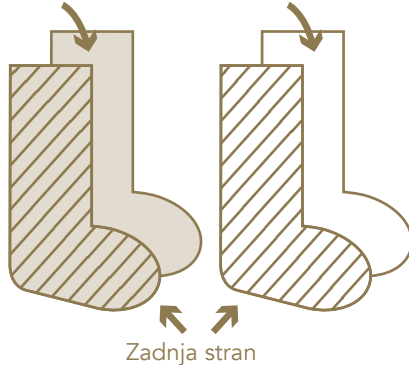

3
Položite žametna škornja
enega na drugega, žametni
površini naj bosta obrnjeni
ena proti drugi.

4
Položite bombažna škornja
enega na drugega, desni
strani naj bosta obrnjeni
ena proti drugi.

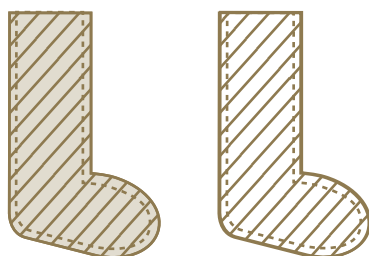

5
Pritrdite oba dela škornjev
z bucikami in ju zašijte skupaj.
Vrh škornja pustite odprt.

Naj bo srečno in veselo

Prvi del postavite tukaj.

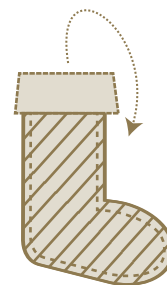

6
Obrnite žametni škorenj od znotraj navzven.

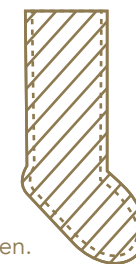

7
Vstavite bombažni škorenj v žametnega.

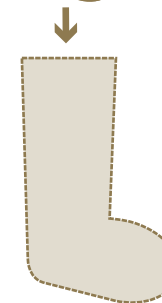

8
Obrnite oba zarobljena roba navzven, za približno 1 cm, in ju zašijte.

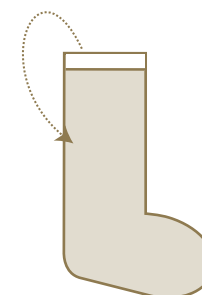

9
Obrnite rob navzven za približno 8



Etikete

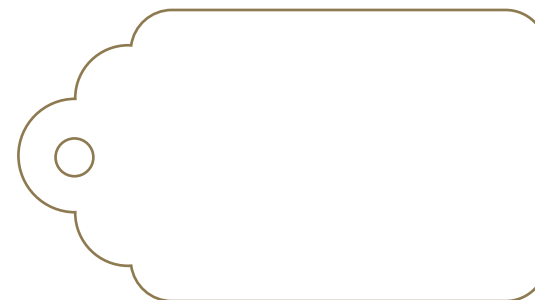
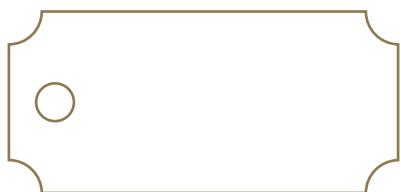
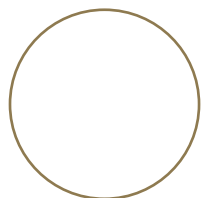
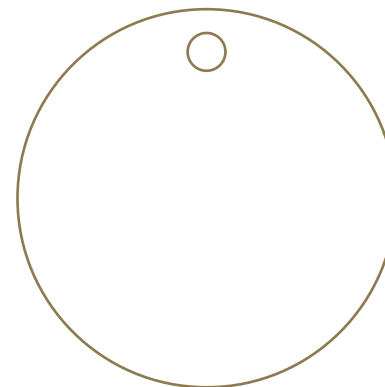
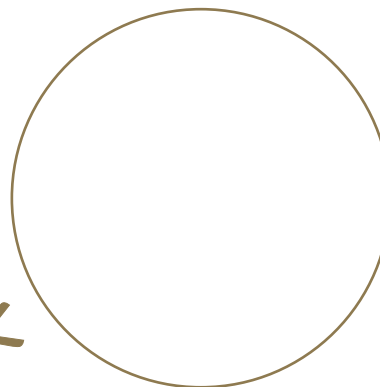
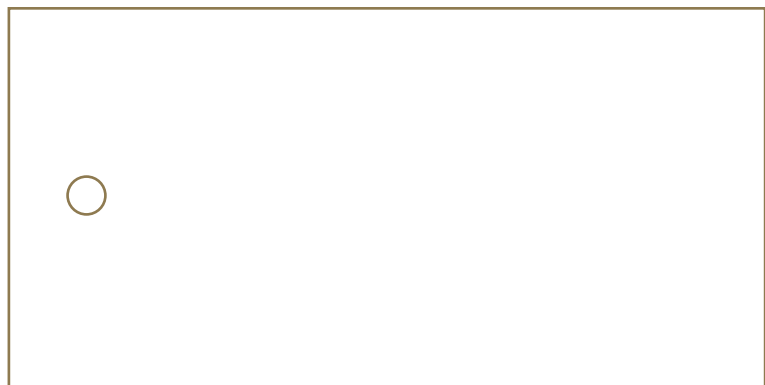

Božična pošta

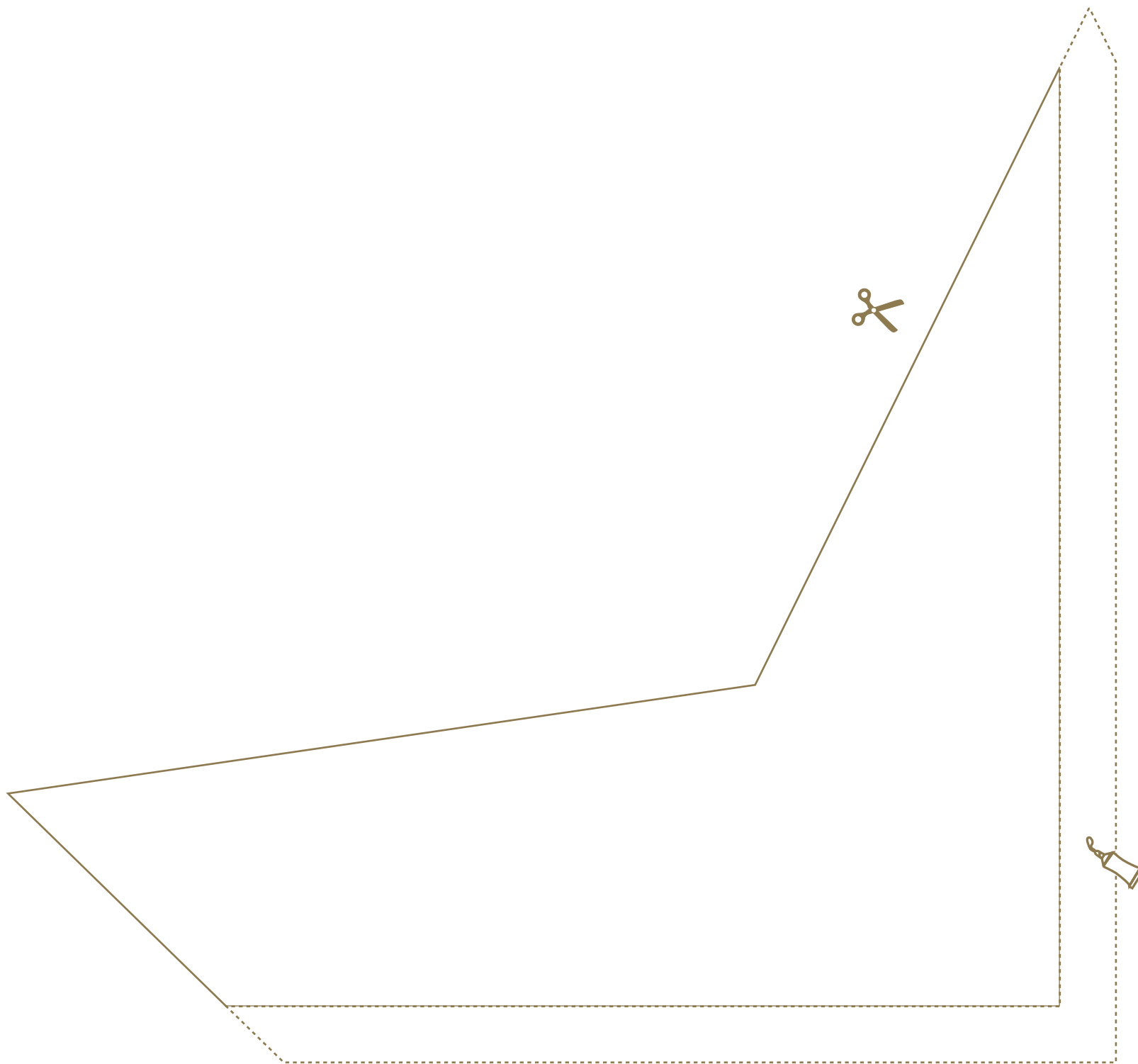

Božična pošta



Božična pošta



Božična pošta

